

MODERNIQUE®

BILANCIO BED DUBLE

IMPORTANT INFORMATION!















WE ADVISE YOU THAT BEFORE STARTING THE ASSEMBLY OF THIS PRODUCT PLEASE FAMILIARISE YOURSELF WITH THE IMPORTANT INSTRUCTIONS LISTED BELOW.

DO NOTS

DO NOT OVER TIGHTEN ANY PART OF THIS ASSEMBLY.
DO NOT USE WASHING POWDER OR OTHER SUBSTANCES CONTAINING ABRASIVES WHEN CLEANING THE FURNITURE.
AS THESE MAY SCRATCH THE FURNITURE.
DO NOT USE ANY TOOLS OTHER THAN THOSE SHOWN.
DO NOT FOR ANY REASON USE A POWER TOOL TO ASSEMBLE THIS PRODUCT, ITS USE COULD MAKE THIS PRODUCT UNSAFE.
DO NOT DRAG FULLY ASSEMBLED FURNITURE. WE RECOMMEND 2 PEOPLE
TO LIFT FURNITURE CLEAR OF THE FLOOR TO MOVE.

DO'S

DO USE A DAMP CLOTH(NOT WET) DRY DUSTER FOR CLEANING THE FURNITURE
DO TIGHTEN UP THE HARDWARES FROM TIME TO TIME DEPENDING ON THE USE OF PRODUCT. THIS IS COMPLETELY NORMAL FOR ANY FLAT PACK FURNITURE.

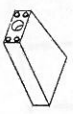
A	BOLT	 M8 x 25mm	X 12	1	HEADBOARD		X 1
B	BOLT	 M8 x 35mm	X 3	2	FOOTBOARD		X 1
C	BOLT	 M8 x 45mm	X 4	3	SIDR RAIL		X 2
D	ALLEN KEY	 5x5 x 100mm	X 1	4	CENTER SUPPORT BAR		X 1
E	CAP	 SINGLE	X 28	5	SUPPORT BAR		X 1
F	CAP	 DOUBLE	X 14	6	SUPPORT LEG		X 2
G	BOLT	 M8 x 15mm	X 4	7	SLATS		X 28
				8	FEET		X 4

KINDLY FOLLOW ASSEMBLY INSTRUCTION STEP BY STEP

1

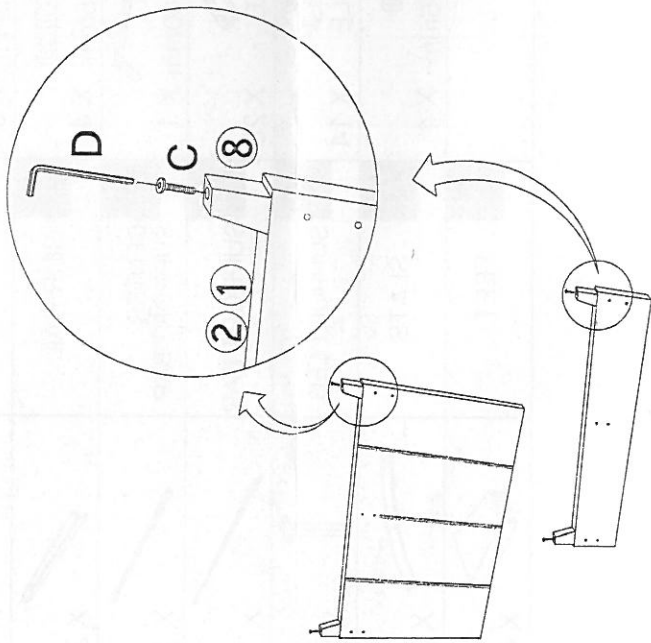

C	BOLT M8 x 45mm	X 4	1	HEADBOARD	X 1
D	ALLEN KEY 5 x5x 100mm	X 1	2	FOOTBOARD	X 1
			8	FEET	X 4

2

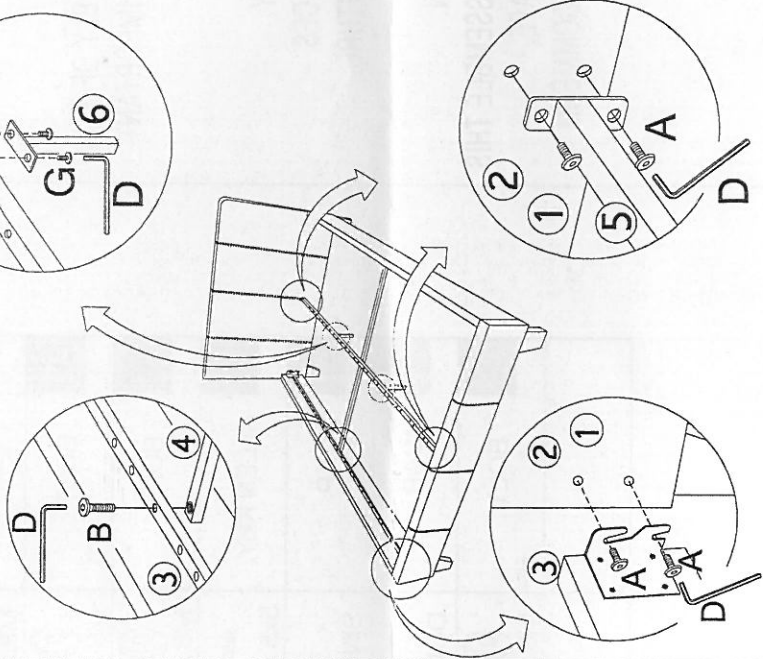

A	BOLT M8 x 25mm	X 12	3	SIDR RAIL	X 2
B	BOLT M8 x 35mm	X 3	4	CENTER SUPPORT BAR	X 1
D	ALLEN KEY 5 x5x 100mm	X 1	5	SUPPORT BAR	X 1
G	BOLT M8 x 15mm	X 4	6	SUPPORT LEG	X 2

3

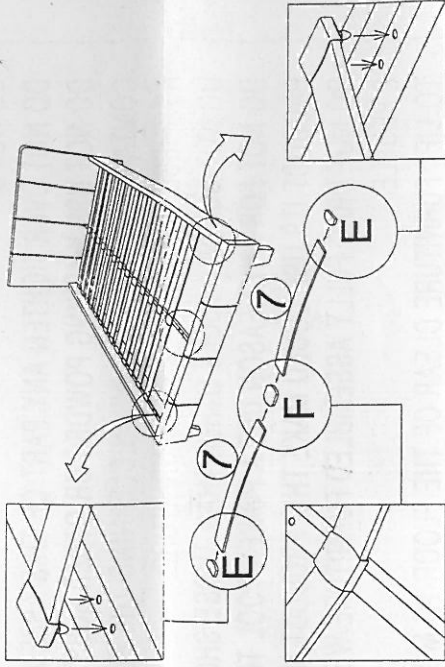

E	CAP	SINGLE	X 28	7	SLATS	X 28
F	CAP	DOUBLE	X 14			